

Toilette BRAVO disabili (cod.S3AH01)

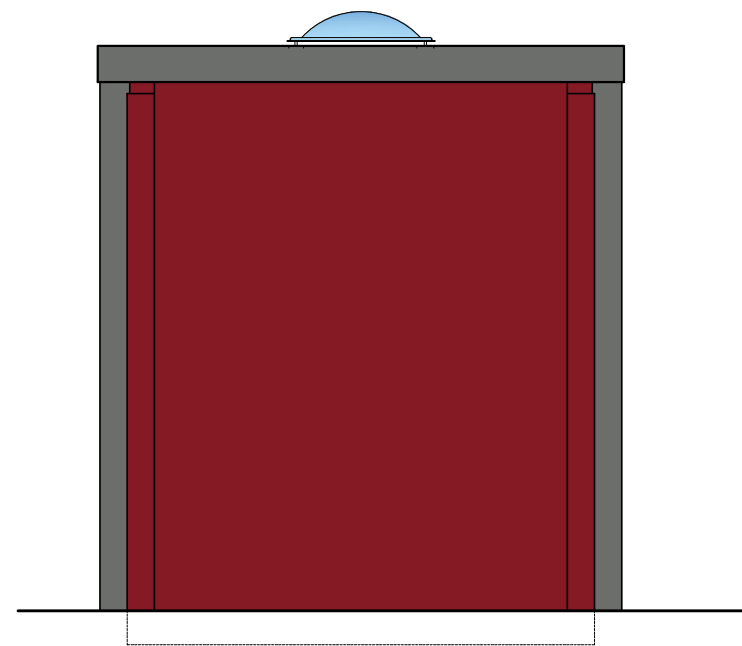

Toilette BRAVO disabili + normodotato (cod.S3ANH01)

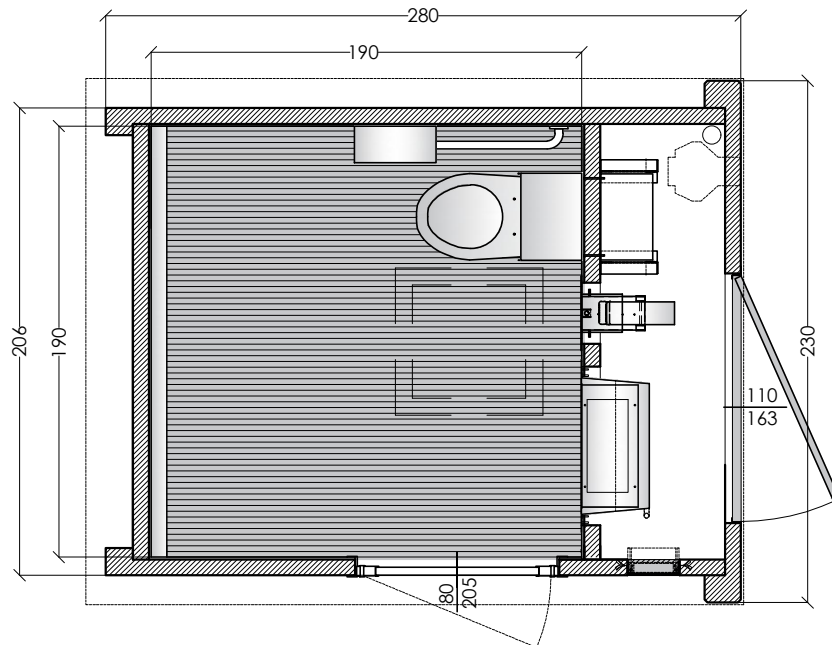
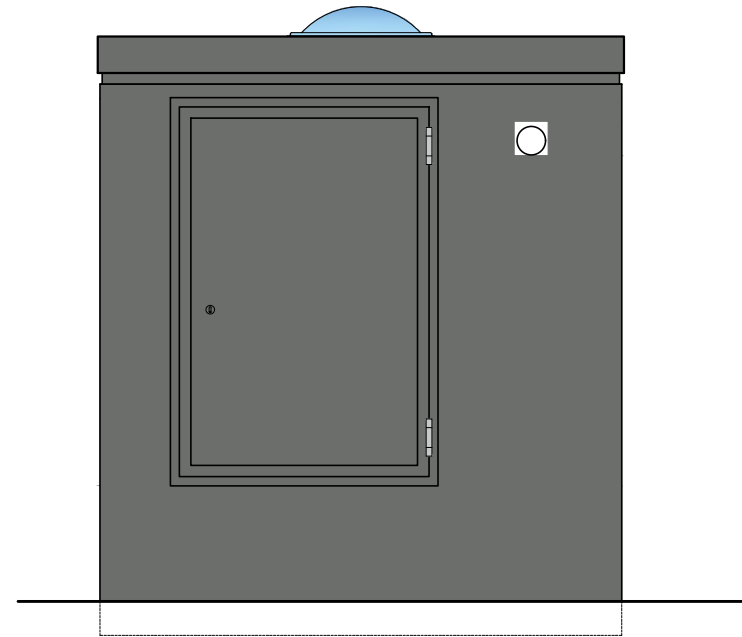
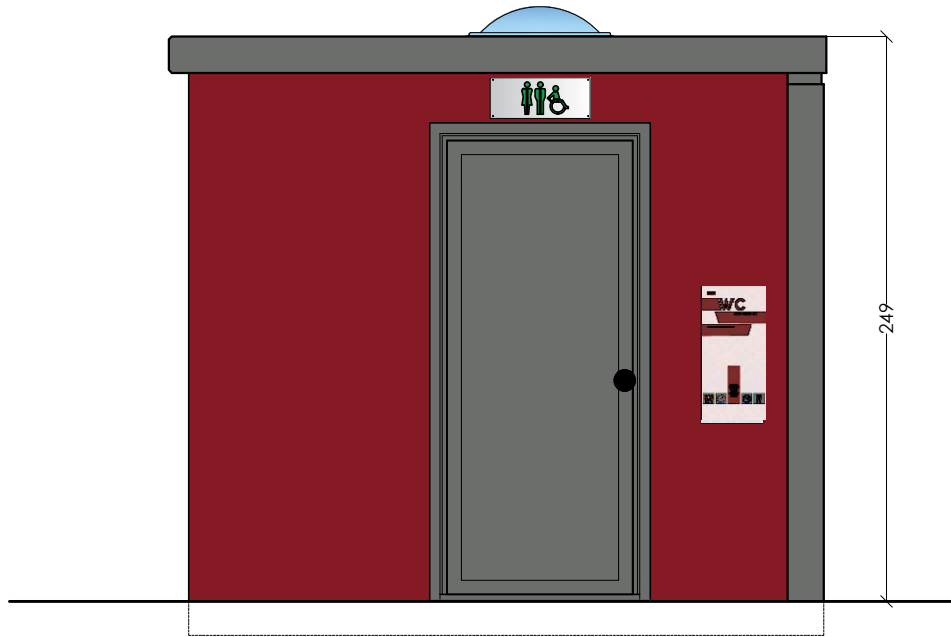
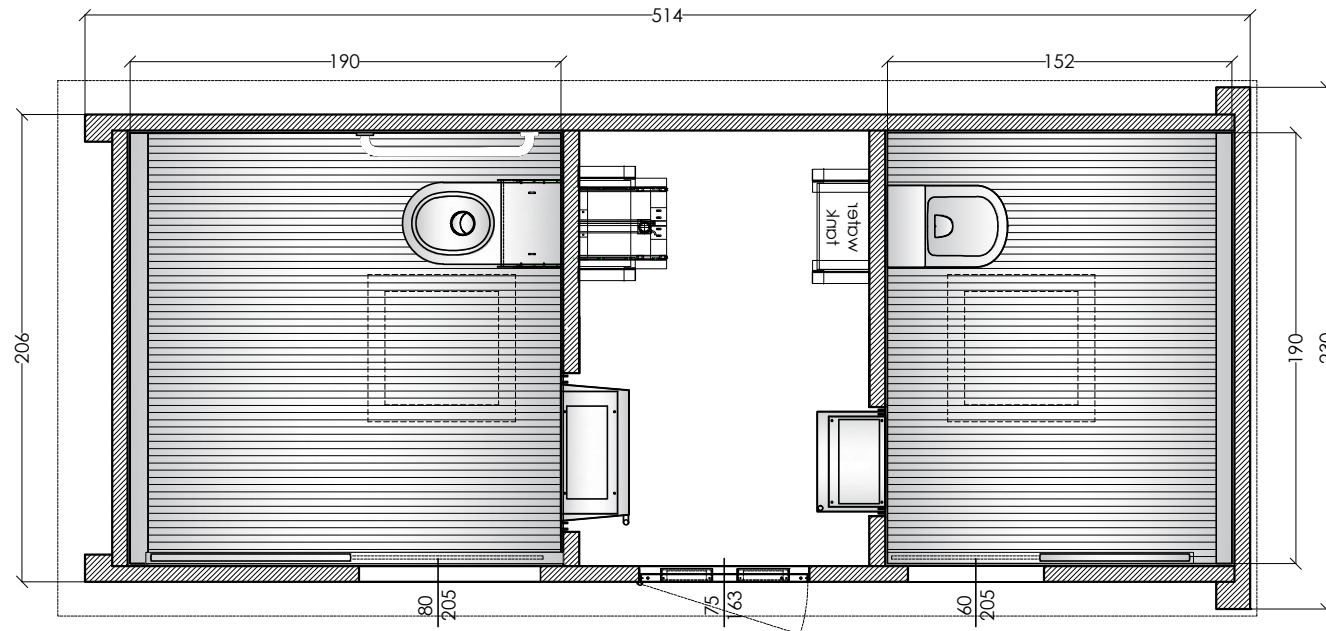
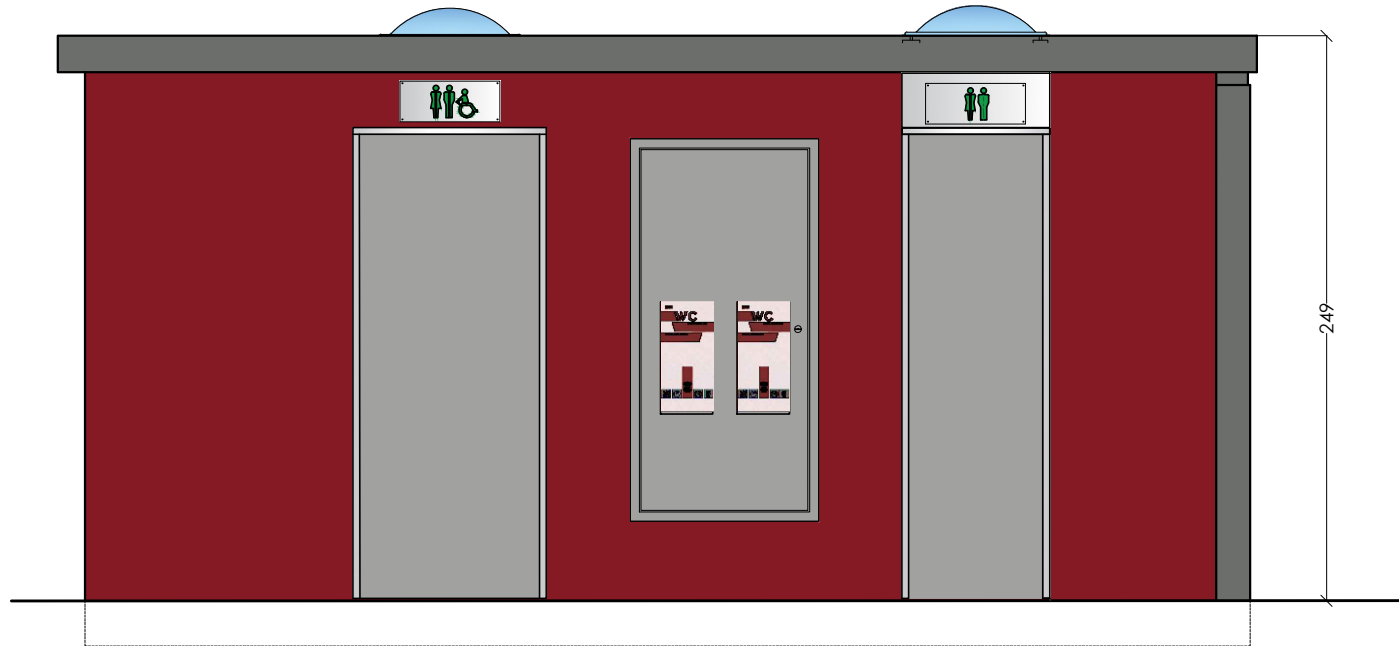

Toilette BIRO normodotati (cod.S3AN01)

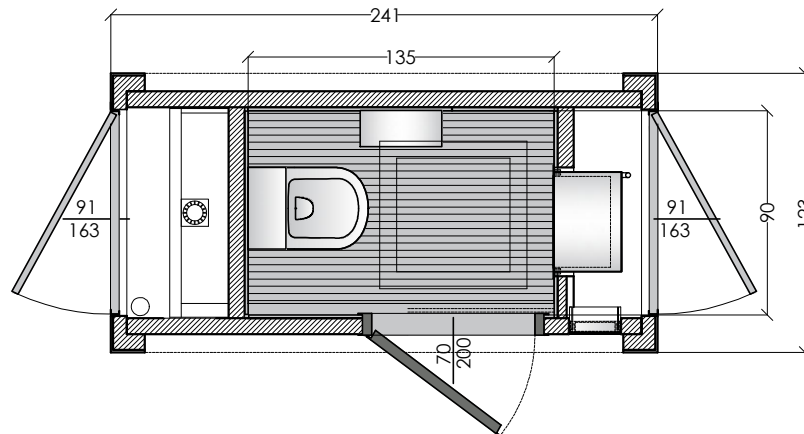
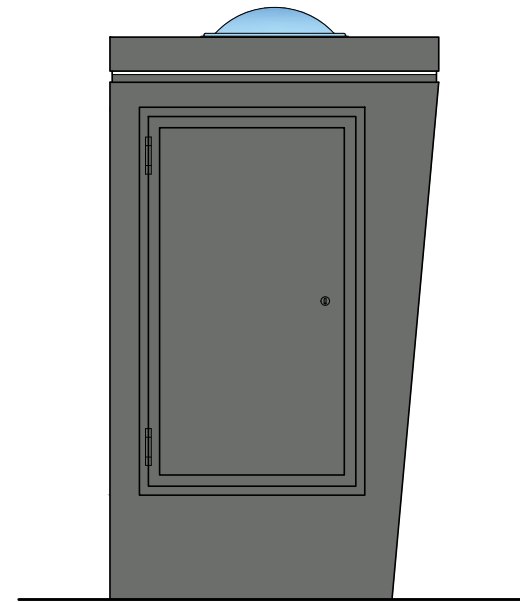
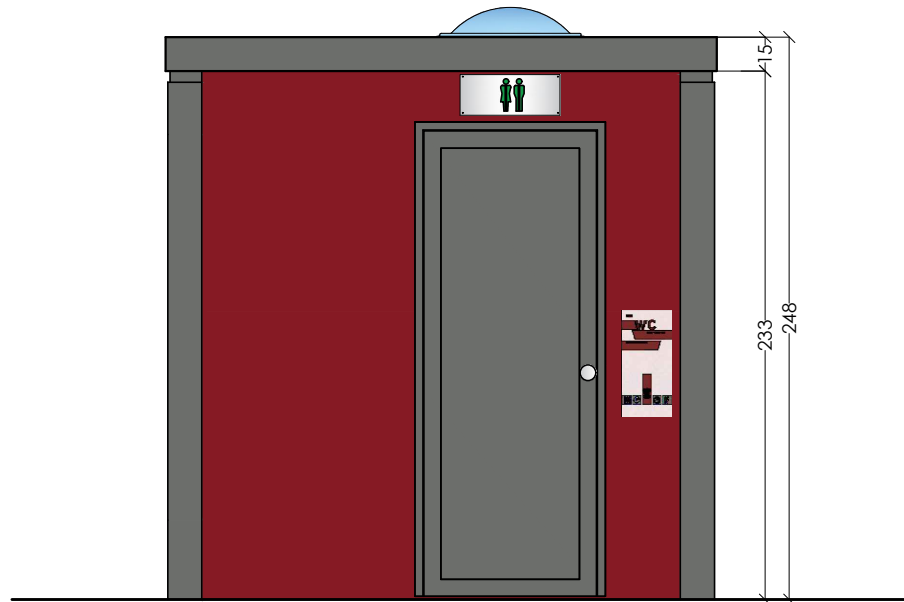

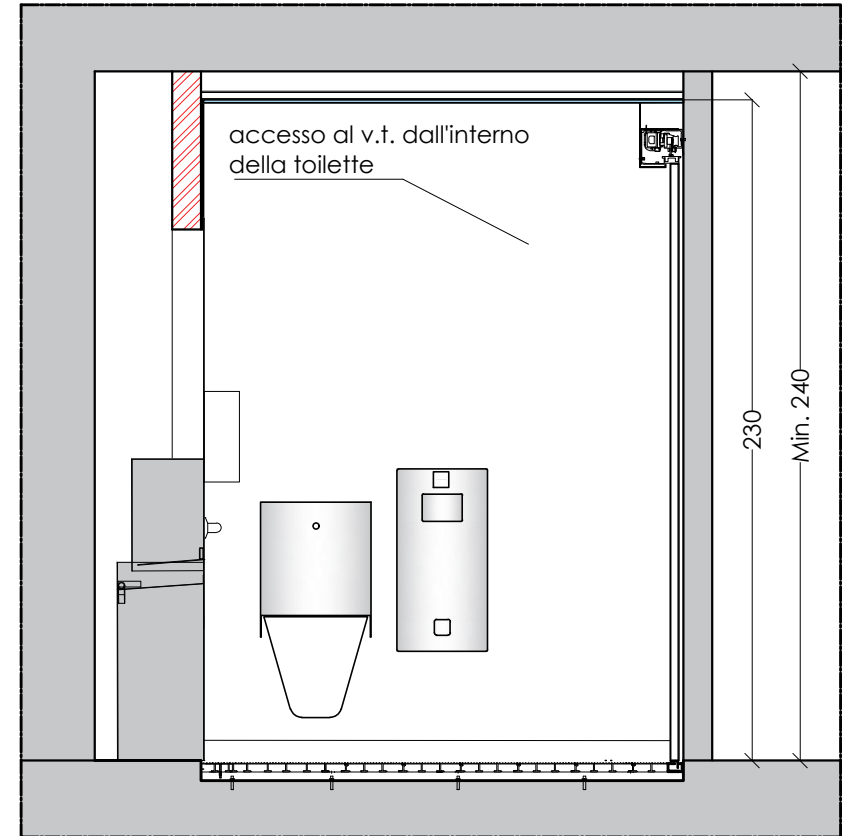
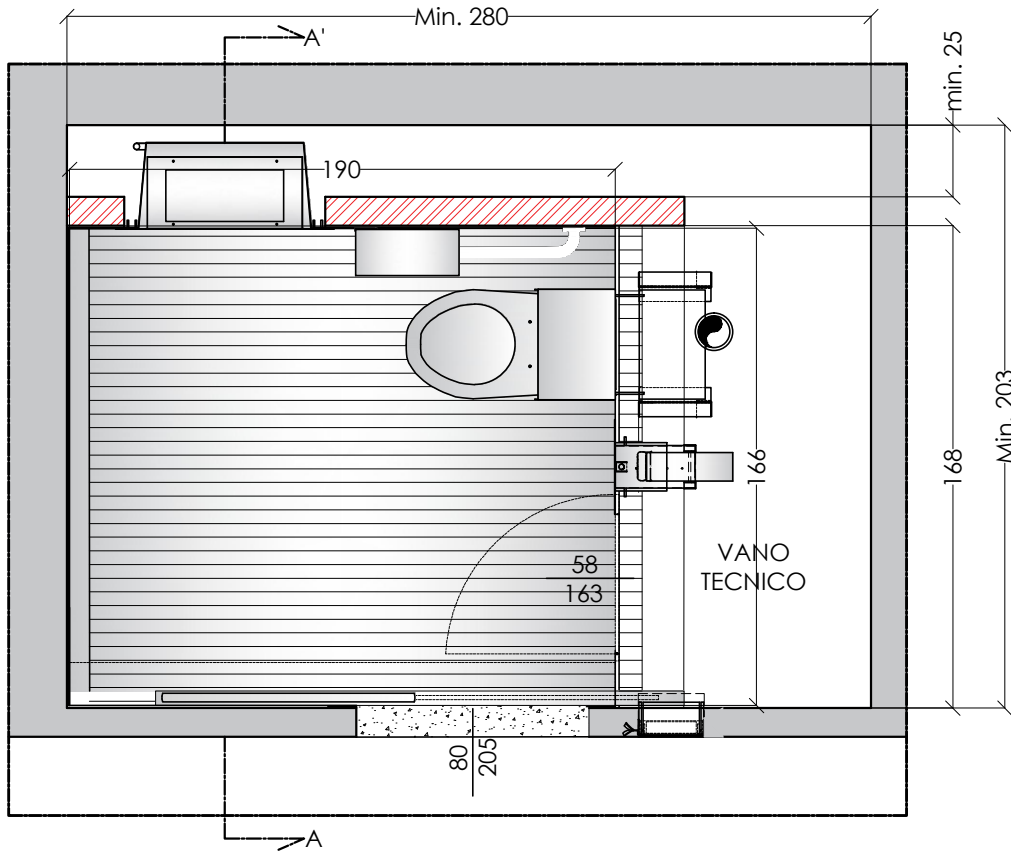

SEZIONE A:A'